

Desde 1964

# CATÁLOGO



		SILLAS TOCADOR	<b>P. 03-08</b>
		SILLONES BARBERO	<b>P. 09-12</b>
		LAVACABEZAS	<b>P.13-15</b>
		CLIMAZONES	<b>P. 16-17</b>
		SECADORES	<b>P. 18-19</b>
		VAPOR Y ESTERILIZADORES	<b>P. 20</b>
		TABURETES	<b>P. 21</b>
		PLATOS	<b>P. 22</b>
		SOPORTES Y CARROS	<b>P. 23</b>
		TEJAS Y CUBETAS	<b>P. 24</b>
		COMPLEMENTOS	<b>P. 25</b>
		TOCADORES	<b>P. 26</b>
		MOBILIARIO NIÑOS	<b>P. 27</b>
		ESTÉTICA	<b>P. 28-29</b>
		TAPIZADOS	<b>P. 20-31</b>



ref. 101  
**SILLÓN DRAM**  
Color negro

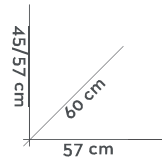

ref. 102  
**SILLÓN PIZZICATTO**  
Color negro

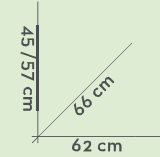

ref. 103  
**SILLÓN INIX**  
Color negro

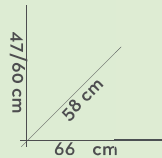

ref. 104  
**SILLÓN ANIX**  
Color negro

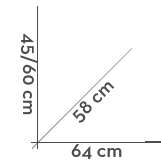



ref. 105  
**SILLÓN TEIDE**



ref. 106  
**SILLÓN ETNA**



ref. 107  
**SILLÓN MAGMA**



ref. 108  
SILLÓN POMPEYA



ref. 109  
SILLÓN DARI



ref. 110  
**SILLÓN KARMO**



ref. 111  
**SILLÓN VENUS**

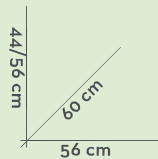

ref. 112  
**SILLÓN ITACA**

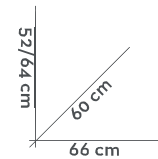

ref. 113  
**SILLÓN OASIS**



ref. 114  
SILLÓN **JUPITER**



ref. 115  
SILLÓN **EVEREST**





ref. 116  
SILLÓN CABALLERO **DIANA**  
Color negro



ref. 117  
SILLÓN CABALLERO **ANIX 4000**  
Color blanco y negro



ref. 118  
SILLÓN CABALLERO **METEOR**  
Color negro



ref. 119  
SILLÓN CABALLERO **ANIX 6000**  
Color negro



ref. 120  
SILLÓN CABALLERO ANIX 7000



ref. 121  
SILLÓN ANIX 7001



ref. 122  
SILLÓN ANIX 7002

54/71 cm  
125/160 cm  
69 cm  
Peso 62 kg  
Base diámetro 67 cm



ref. 123  
SILLÓN ANIX 7003



200 cm  
150 cm

∅  
25 cm



88 cm

ref. 124  
BARBER  
POLE



ref. 125  
MUEBLE TOCADOR BARBERO



ref. 201  
**LAVACABEZAS NEPTUNO**  
Color negro



ref. 202  
**LAVACABEZAS ANIX 2100**  
Color negro, porcelana blanca y negra



ref. 203  
**LAVACABEZAS ANIX 990**  
Color negro, porcelana blanca



ref. 204  
**LAVACABEZAS ETNA**  
Porcelana blanca o negra, tapizado en color.  
Opción: apoya pies eléctrico



ref. 205

### LAVACABEZAS **K2**

Porcelana blanca o negra con antigoteo. Apoya pies eléctrico.  
Opción: masaje mediante vibración en respaldo, asiento y pies.  
Mueble ac/inoxidable. Tapizado en color

ref. 206

### LAVACABEZAS **EVEREST**

Porcelana blanca o negra con antigoteo. Apoya pies eléctrico.  
Opción: masaje mediante vibración en respaldo, asiento y pies.  
Mueble ac/inoxidable. Tapizado en color.



ref. 301  
**CLIMAZÓN CIX3000**  
Negro con pie estrella  
Sólo calor



ref. 302  
**CLIMAZÓN CIX3000**  
Negro con brazo  
Sólo calor





ref. 303  
**CLIMAZÓN ANIX 3600**  
Calor + Aire + Ozono  
Color plata - 1400 watt



ref. 304  
**CLIMAZÓN ANIX 3601**  
Calor + Aire + Ozono  
Color plata - 1400 watt



ref. 401

## SECADOR **GÉMINIS**

Todos los colores. Con pie. 2 velocidades.  
Garantía 3 años, motor 5 años. 1200 watt



ref. 402

## SECADOR **GÉMINIS**

Todos los colores. Con brazo mural. 2 velocidades.  
Garantía 3 años, motor 5 años. 1200 watt



ref. 403  
SECADOR **GAMMA** 2 velocidades.  
Color blanco, negro, plata y titanio.  
Con pie manual. Garantía 2 años. 900 watt



ref. 404  
SECADOR **GAMMA** 2 velocidades  
Color blanco, negro, plata y titanio, con brazo mural.  
Garantía 2 años. 900 watt



ref. 501  
Modelo **ANIX 2000**  
VAPOR CAPILAR  
Color blanco con pie



ref. 502  
ESTERILIZADOR  
ULTRAVIOLETA  
Modelo **PLUS**  
8 watt

ref. 503  
ESTERILIZADOR  
ULTRAVIOLETA  
Modelo **HEKO**  
6 watt



ref. 504  
CALENTADOR TOALLAS Y ESTERILIZADOR  
7Kg 200 watt  
23 Litros  
Temperatura 60-95°  
UV-C 254NM

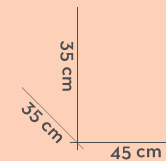

ref. 602  
TABURETE  
BLANCO



ref. 601  
TABURETE  
NEGRO



ref. 603  
TABURETE NEGRO  
Con respaldo y pie cromado



ref. 604  
TABURETE  
RODEO  
Con pie



ref. 605  
TABURETE  
CROMADO  
Con pie cromado





ref. 703  
PLATO  
ACERO INOX  
Redondo con pie.  
Opción: con ruedas/sin ruedas

38 cm

75/120 cm



38 cm

75/120 cm

ref. 704  
PLATO ACERO INOX  
Redondo con pie aluminio y ruedas

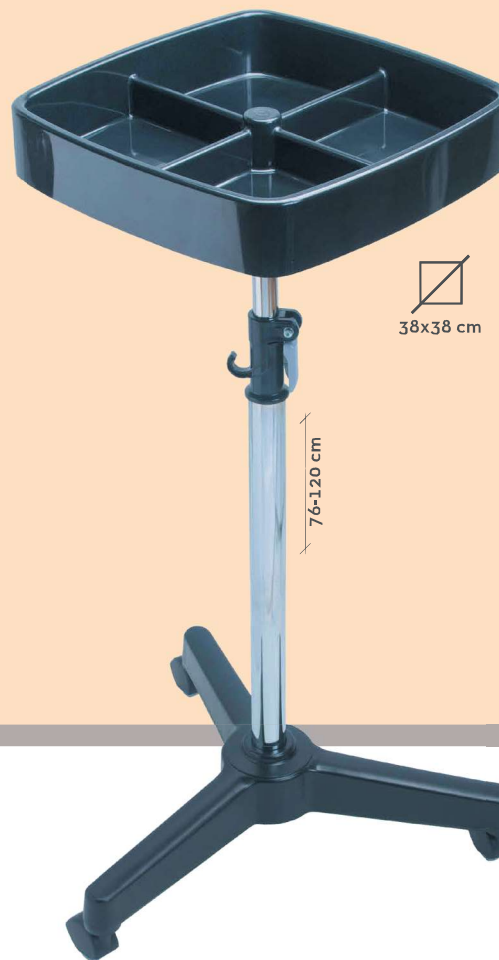

38x38 cm

76-120 cm

ref. 701  
PLATO PLÁSTICO  
Redondo.  
Opción: con ruedas/sin ruedas

ref. 702  
PLATO  
PLÁSTICO  
Cuadrado, 4 departamentos,  
Opción: con ruedas/sin ruedas

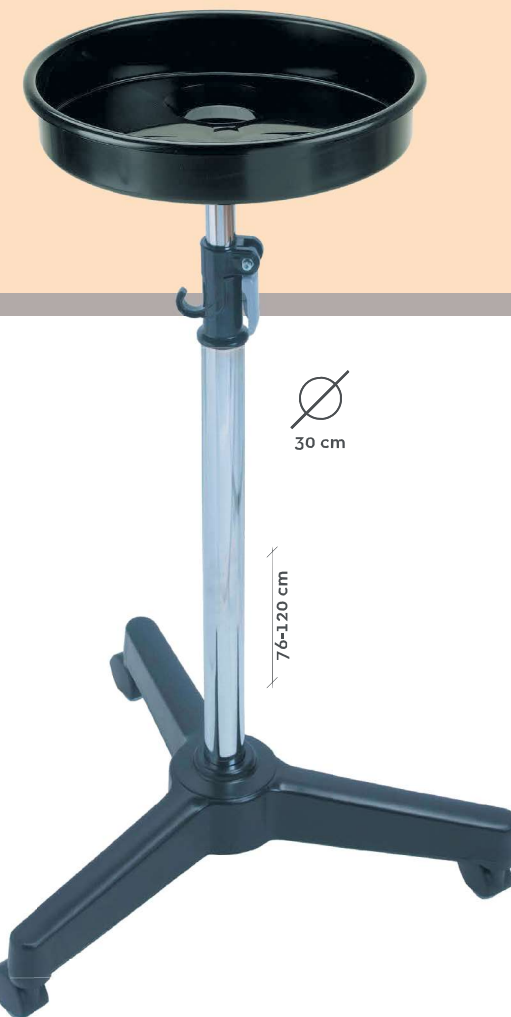

30 cm

76-120 cm

**ref. 802**  
**APOYA PIES PEDICURA**  
Regulable e inclinable con pie



**ref. 801**  
**APOYANUCA**  
Regulable con pie



**ref. 804**  
**SOPORTE MANIQUÍ**  
Regulable. Con pie metálico, d. 35 cm  
Soporte superior giratorio 360°



**ref. 803**  
**SOPORTE TATTOO**  
Reclinable y regulable  
con pie



**ref. 805**  
**CARRO**  
**ANIX 100**  
Laterales plegables



90 cm  
36 cm  
38 cm

ref. 901  
LAVACABEZAS  
1SERVICIO  
Encimera inox

95/105 cm  
25 cm  
25 cm



ref. 902  
SILLA  
LAVACABEZAS  
Reclinable



90cm  
60 cm

ref. 903  
CUBETA  
PLÁSTICO  
Regulable e inclinable con  
pie y goma de desagüe



77/110 cm

ref. 904  
TEJA LARGA  
PLÁSTICO  
Regulable e inclinable con pie



77/100 cm

ref. 905  
TEJA PORTÁTIL  
para silla







ref. 1001  
APOYA PIES  
MODELO **INOX**

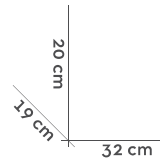

ref. 1003  
PORTA SECADOR  
Espiral cromado



ref. 1002  
APOYA PIES  
MODELO **T**  
Cromado



ref. 1004  
PORTA SECADOR  
ALUMINIUM

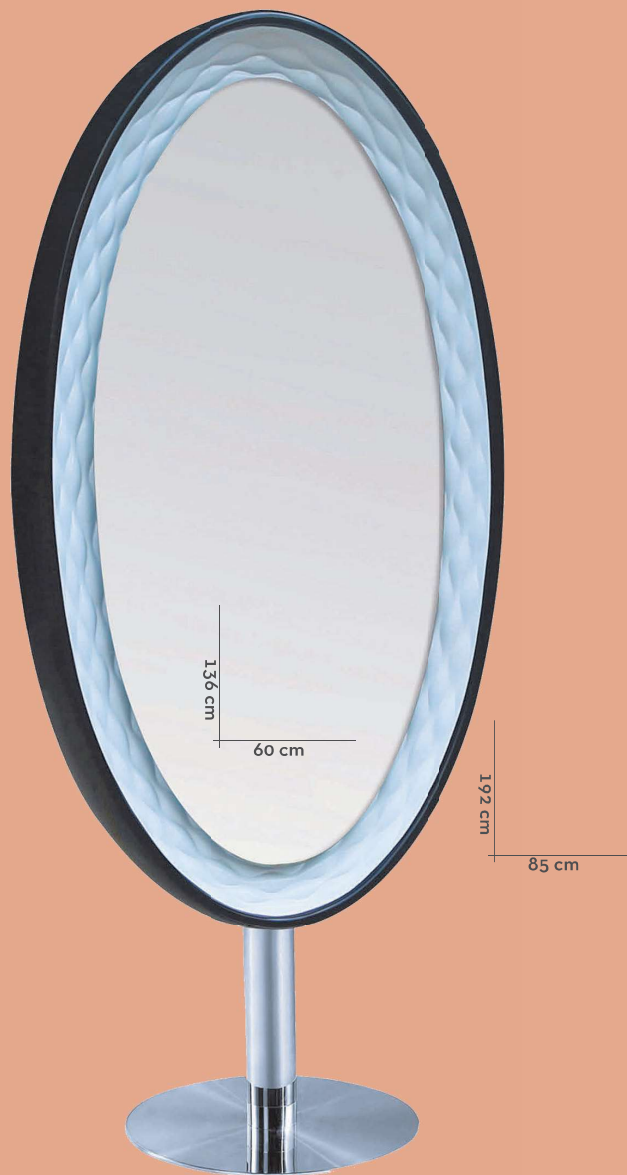

ref. 1105  
**TOCADOR  
 DE LUXE**  
 Doble espejo. Luz LED



ref. 1102  
**TOCADOR  
 ROYAL**  
 Estructura metálica.  
 Negro, blanco y gris

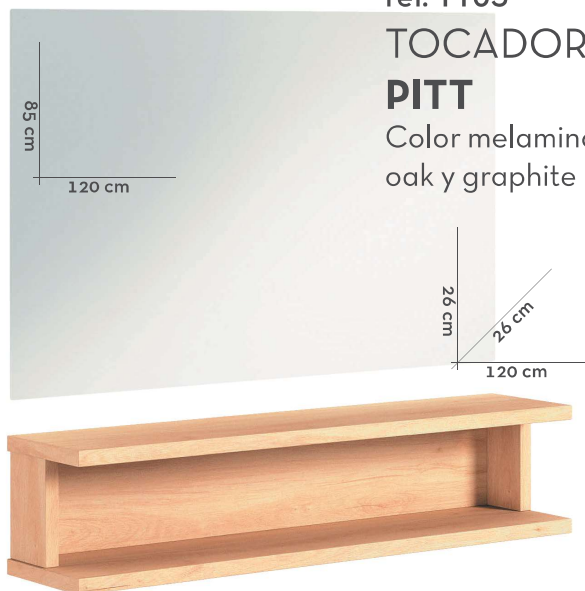
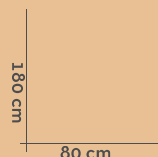

ref. 1103  
**TOCADOR  
 PITT**  
 Color melamina,  
 oak y graphite

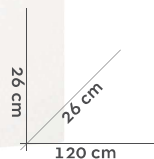

ref. 1104  
**TOCADOR  
 CASTELO**  
 Estructura metálica.

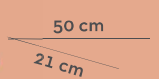
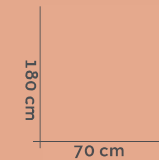
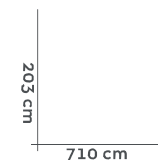

ref. 1101  
**TOCADOR**  
 Modelo **BASIC**  
 Estructura madera.  
 Tapizado blanco



ref. 1201  
COCHE BOMBEROS  
MODELO **DE LUXE**

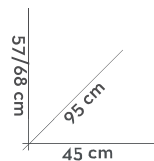
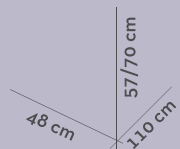

ref. 1202  
COCHE **BABY1939**

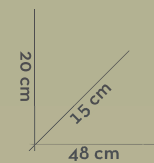

ref. 1203  
**PUFF NIÑO**  
Con faldón.  
Color negro

ref. 1301  
ESPEJO TOCADOR  
ESTÉTICA

Blanco  
Superficie mesa de cristal color negro



60/77 cm

ref. 1304  
FUSOR CERA  
**DM2000**  
de 9 kg



ref. 1303  
FUSOR CERA  
**DM2000**  
de 4 kg



ref. 1302  
FUSOR CERA  
**DM2000**  
0,250 kg

ref. 1305  
VAPOR FACIAL





ref. 1307  
CAMILLA ESTÉTICA  
3 cuerpos



ref. 1306  
SILLÓN  
ESTÉTICA  
Color blanco



ref. 1308  
SILLÓN  
MASAJE  
Color blanco y negro

# TAPIZADOS

NUESTRA AMPLIA GAMA DE TAPIZADOS SE ADECUA A TODOS LOS ESTILOS DE SALONES DE BELLEZA.

El revestimiento protector del tapizado hace que el mantenimiento resulte sencillo. Incluso las manchas más difíciles se pueden limpiar sin esfuerzo con un paño seco y la suciedad más persistente puede eliminarse con alcohol isopropílico, las manchas desaparecen en pocos segundos. Además este tapizado proporciona una gran resistencia incomparable a los rasguños, las marcas y las abrasiones.

## VALENCIA

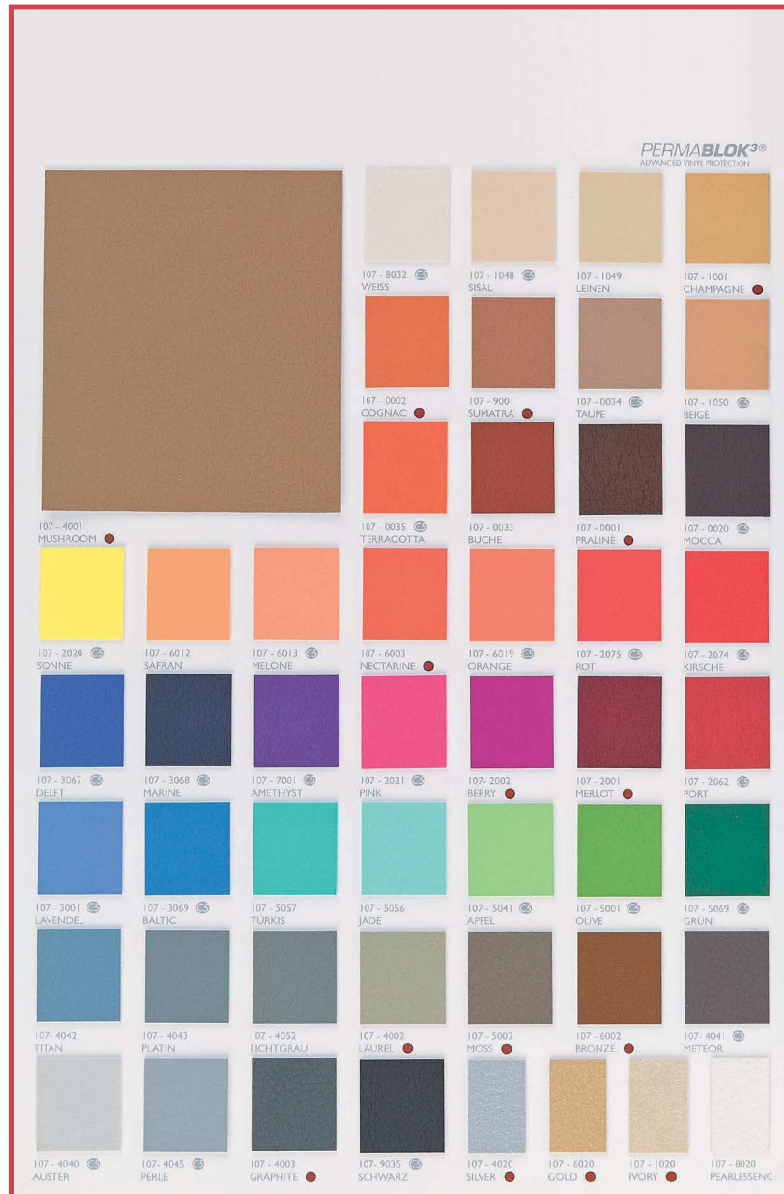

## STAR



## PREMIUM



## GAMA LUXE



### CARACTERÍSTICAS PRINCIPALES

- Resistencia a la abrasión
- Resistencia a la rotura
- Impermeabilidad
- Durabilidad del color a la luz
- Resistencia a las bajas temperaturas
- Resistencia a los microorganismos
- Fácil limpieza
- Retardancia al fuego



**Daniel Mora S. L.**

Pje. General Bassols, 22 bajos • 08005 Barcelona

Tel.: 932250389 - 687 077 958

[danielmora@danielmora.es](mailto:danielmora@danielmora.es)

[www.danielmora.es](http://www.danielmora.es)